

Three-terminal positive voltage regulator

Features

- 1.4V maximum dropout at full load current
- Fast transient response
- Output current limiting
- Built-in thermal shutdown
- Good noise rejection
- 3-Terminal Adjustable or Fixed 1.5V, 1.8V, 1.9V, 2.5V, 3.3V, 5.0V

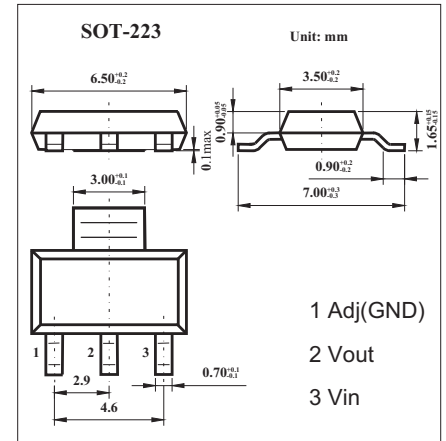

MAXIMUM RATINGS AND CHARACTERISTICS

@ 25°C Ambient Temperature (unless otherwise noted)

Parameter	Symbol	Rating	Unit
DC Supply Voltage	V_{in}	-0.3 to 12	V
Power Dissipation	P_D	Internally Limited	
Thermal Resistance Junction-to-Ambient	θ_{JA}	117	°C/W
Thermal Resistance Junction-to-Case *	θ_{JC}	15	°C/W
Operating Junction Temperature Range	T_{OP}	0 to +150	°C
Storage Temperature	T_{ST}	-65 to +150	°C

* Control Circuitry/Power Transistor

Electrical Specification ($T_A=25^\circ\text{C}$ unless otherwise specified)

Parameter	Testconditions	Min	Typ	Max	Unit
Reference Voltage	T1117-ADJ, $T_J=25^\circ\text{C}, (V_{IN}-V_{OUT})=1.5\text{V}, I_O=10\text{mA}$	1.225	1.250	1.275	V
Output Voltage	T1117-1.5, $I_{OUT} = 10\text{mA}, T_J = 25^\circ\text{C}, 3\text{V} \leq V_{IN} \leq 12\text{V}$	1.470	1.500	1.530	V
	T1117-1.8, $I_{OUT} = 10\text{mA}, T_J = 25^\circ\text{C}, 3.3\text{V} \leq V_{IN} \leq 12\text{V}$	1.764	1.800	1.836	V
	T1117-1.9, $I_{OUT} = 10\text{mA}, T_J = 25^\circ\text{C}, 3.3\text{V} \leq V_{IN} \leq 12\text{V}$	1.862	1.900	1.938	V
	T1117-2.5, $I_{OUT} = 10\text{mA}, T_J = 25^\circ\text{C}, 4\text{V} \leq V_{IN} \leq 12\text{V}$	2.450	2.500	2.550	V
	T1117-3.3, $I_{OUT} = 10\text{mA}, T_J = 25^\circ\text{C}, 4.8\text{V} \leq V_{IN} \leq 12\text{V}$	3.235	3.300	3.365	V
	T1117-5.0, $I_{OUT} = 10\text{mA}, T_J = 25^\circ\text{C}, 6.5\text{V} \leq V_{IN} \leq 12\text{V}$	4.900	5.000	5.100	V
Line Regulation	T1117-XXX, $I_O=10\text{mA}, V_{OUT}+1.5\text{V} < V_{IN} < 12\text{V}, T_J=25^\circ\text{C}$			0.2	%
Load Regulation	T1117-ADJ, $V_{IN}=3.3\text{V}, V_{adj}=0, 0\text{mA} < I_O < 1\text{A}, T_J=25^\circ\text{C}$			1	%
	T1117-1.5, $V_{IN}=3\text{V}, 0\text{mA} < I_O < 1\text{A}, T_J=25^\circ\text{C}$		12	15	mV
	T1117-1.8, $V_{IN}=3.3\text{V}, 0\text{mA} < I_O < 1\text{A}, T_J=25^\circ\text{C}$		15	18	mV
	T1117-1.9, $V_{IN}=3.3\text{V}, 0\text{mA} < I_O < 1\text{A}, T_J=25^\circ\text{C}$		16	19	mV
	T1117-2.5, $V_{IN}=4\text{V}, 0\text{mA} < I_O < 1\text{A}, T_J=25^\circ\text{C}$		20	25	mV
	T1117-3.3, $V_{IN}=5\text{V}, 0\text{mA} < I_O < 1\text{A}, T_J=25^\circ\text{C}$		26	33	mV
	T1117-5.0, $V_{IN}=8\text{V}, 0\text{mA} < I_O < 1\text{A}, T_J=25^\circ\text{C}$		40	50	mV
Dropout Voltage ($V_{IN}-V_{OUT}$)	T1117-XXX, $I_{OUT} = 1\text{A}, \Delta V_{OUT}=0.1\%V_{OUT}$		1.3	1.4	V
Current Limit	T1117-XXX, $(V_{IN}-V_{OUT}) = 5\text{V}$	1.1			A
Minimum Load Current	T1117-XXX, $0^\circ\text{C} \leq T_J \leq 125^\circ\text{C}$		5	10	mA
Thermal Regulation	$T_A=25^\circ\text{C}, 30\text{ms pulse}$		0.008	0.04	%/W
Ripple Rejection	F=120Hz, $C_{OUT}=25\mu\text{F}$ Tantalum, $I_{OUT}=1\text{A}$				
	T1117-XXX, $V_{IN}=V_{OUT}+3\text{V}$		60	70	dB
Temperature Stability	$I_O=10\text{mA}$		0.5		%

RATINGS AND CHARACTERISTIC CURVES

■ Block Diagram

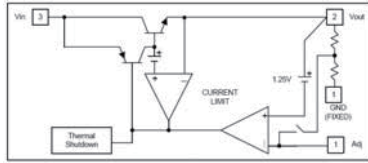

■ Typical Characteristics

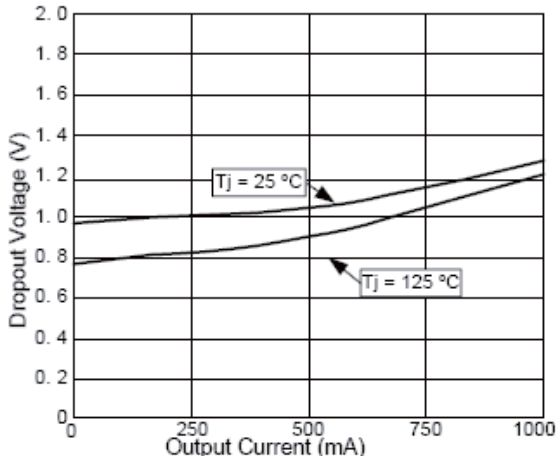

Fig.1 Dropout Voltage vs Output Current

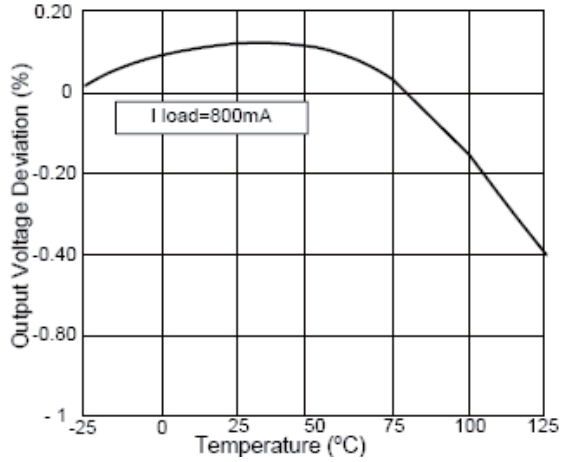

Fig.2 Load Regulation vs Temperature

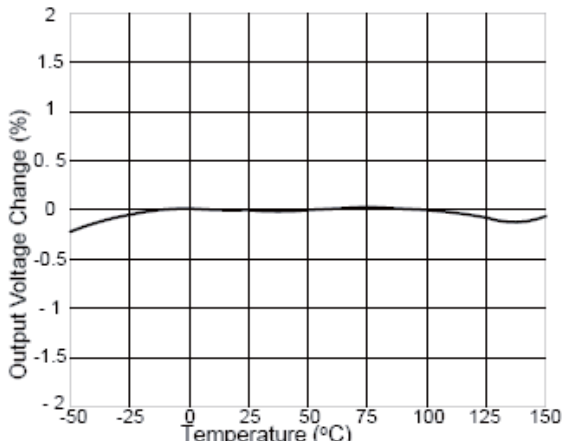

Fig.3 Percent Change in Output Voltage vs Temperature

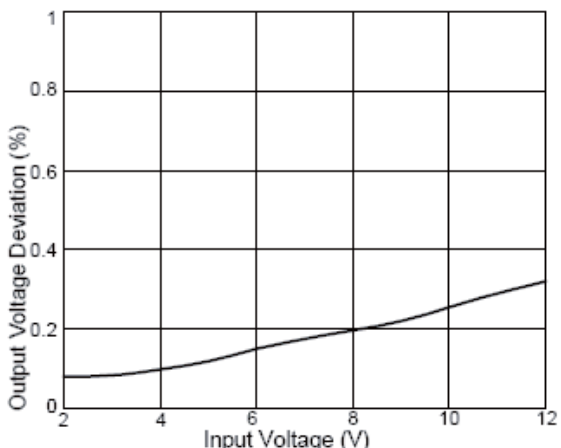

Fig.4 Line Regulation

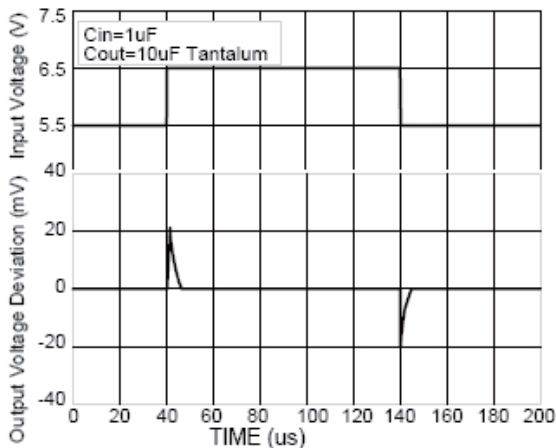

Fig.5 Line Transient Response

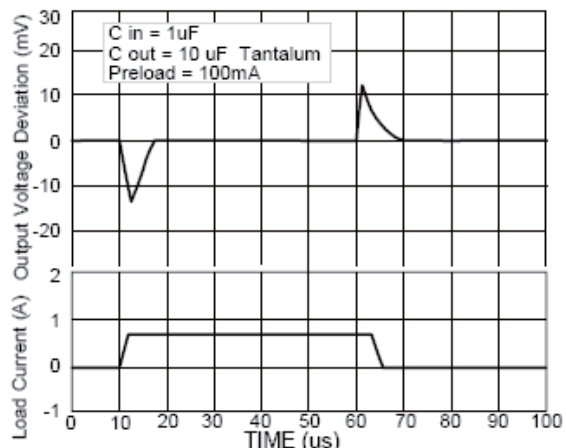

Fig.6 Load Transient Response