

TO-92 Plastic-Encapsulate Transistors

FEATURES

- Darlington Transistors
- TRANSISTOR (NPN)

MECHANICAL DATA

- Case style:TO-92 molded plastic
- Mounting position:any

TO-92

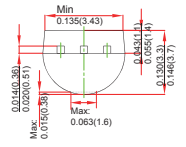
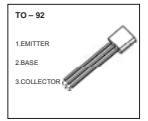
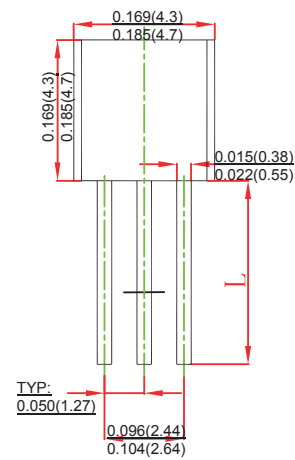

MAXIMUM RATINGS AND CHARACTERISTICS

@ 25°C Ambient Temperature (unless otherwise noted)

Symbol	Parameter	Value	Unit
V_{CB0}	Collector-Base Voltage	30	V
V_{CEO}	Collector-Emitter Voltage	30	V
V_{EB0}	Emitter-Base Voltage	10	V
I_C	Collector Current -Continuous	0.5	A
P_D	Collector Power Dissipation	625	mW
$R_{\theta JA}$	Thermal Resistance from Junction to Ambient	200	°C /W
T_j	Junction Temperature	150	°C
T_{stg}	Storage Temperature	-55~+150	°C

ORDERING INFORMATION

Part Number	Package	Packing Method	Pack Quantity
MPSA13	TO-92	Bulk	1000pcs/Bag
MPSA13-TA	TO-92	Tape	2000pcs/Box

Parameter	Symbol	Test conditions	Min	Typ	Max	Unit
Collector-base breakdown voltage	$V_{(BR)CBO}$	$I_C=0.1mA, I_E=0$	30			V
Collector-emitter breakdown voltage	$V_{(BR)CEO}$	$I_C=1mA, I_B=0$	30			V
Emitter-base breakdown voltage	$V_{(BR)EBO}$	$I_E=0.1mA, I_C=0$	10			V
Collector cut-off current	I_{CBO}	$V_{CB}=30V, I_E=0$			0.1	μA
Emitter cut-off current	I_{EBO}	$V_{EB}=10V, I_C=0$			0.1	μA
DC current gain	$h_{FE(1)}$	$V_{CE}=5V, I_C=10mA$	5000			
	$h_{FE(2)}$	$V_{CE}=5V, I_C=100mA$	10000			
Collector-emitter saturation voltage	$V_{CE(sat)}$	$I_C=100mA, I_B=0.1mA$			1.5	V
Base-emitter voltage	V_{BE}	$V_{CE}=5V, I_C=100mA$			2.0	V
Current gain-bandwidth product	f_T	$V_{CE}=5V, I_C=10mA, f=100MHz$	125			MHz

*Pulse test: pulse width $\leq 300\mu s$, duty cycle $\leq 2.0\%$.

Marking	MPSA13
---------	--------

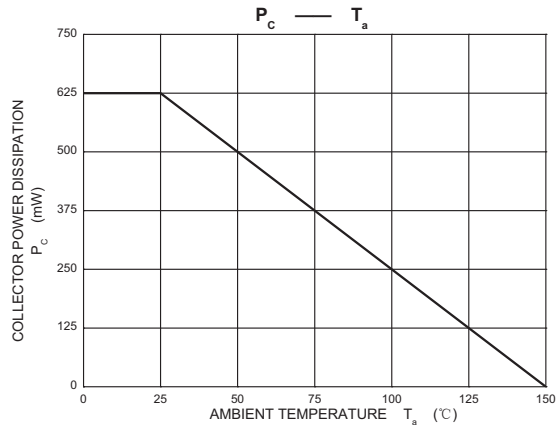
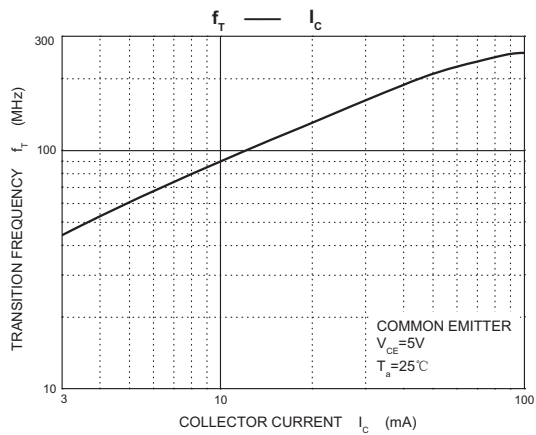
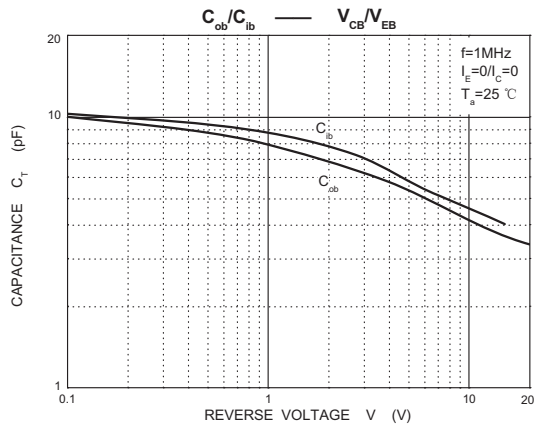
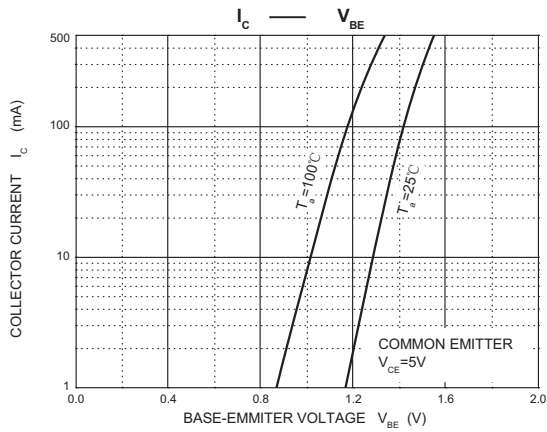
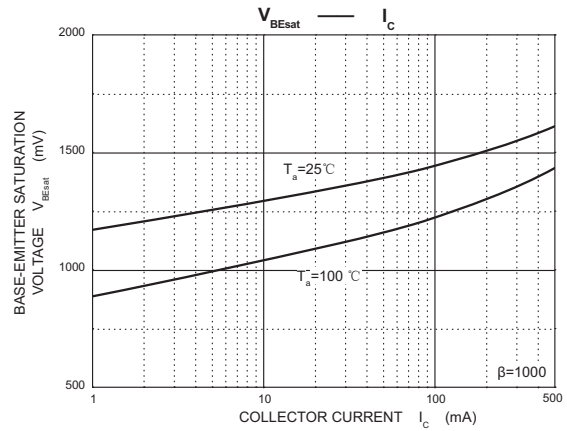
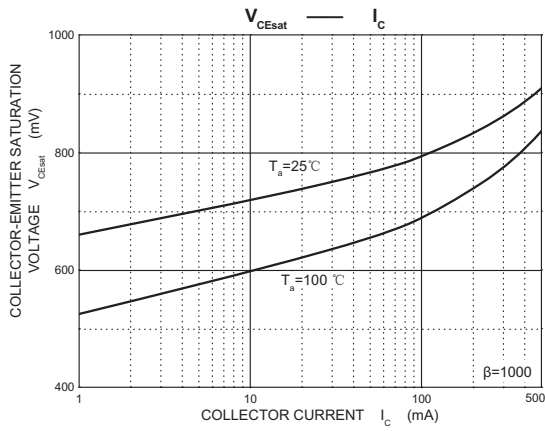
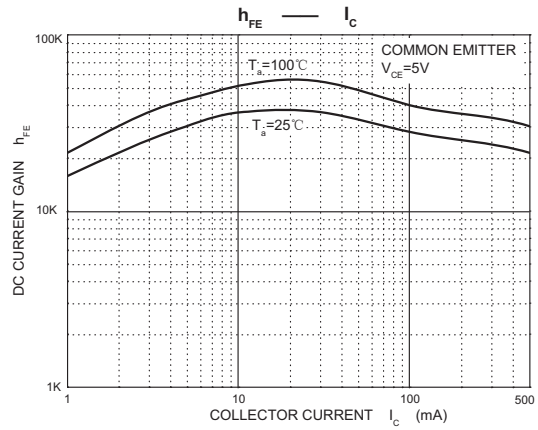
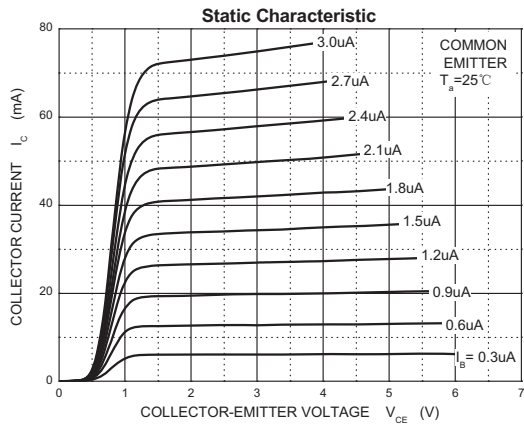

TO-92 PACKAGE TAPEING DIMENSION

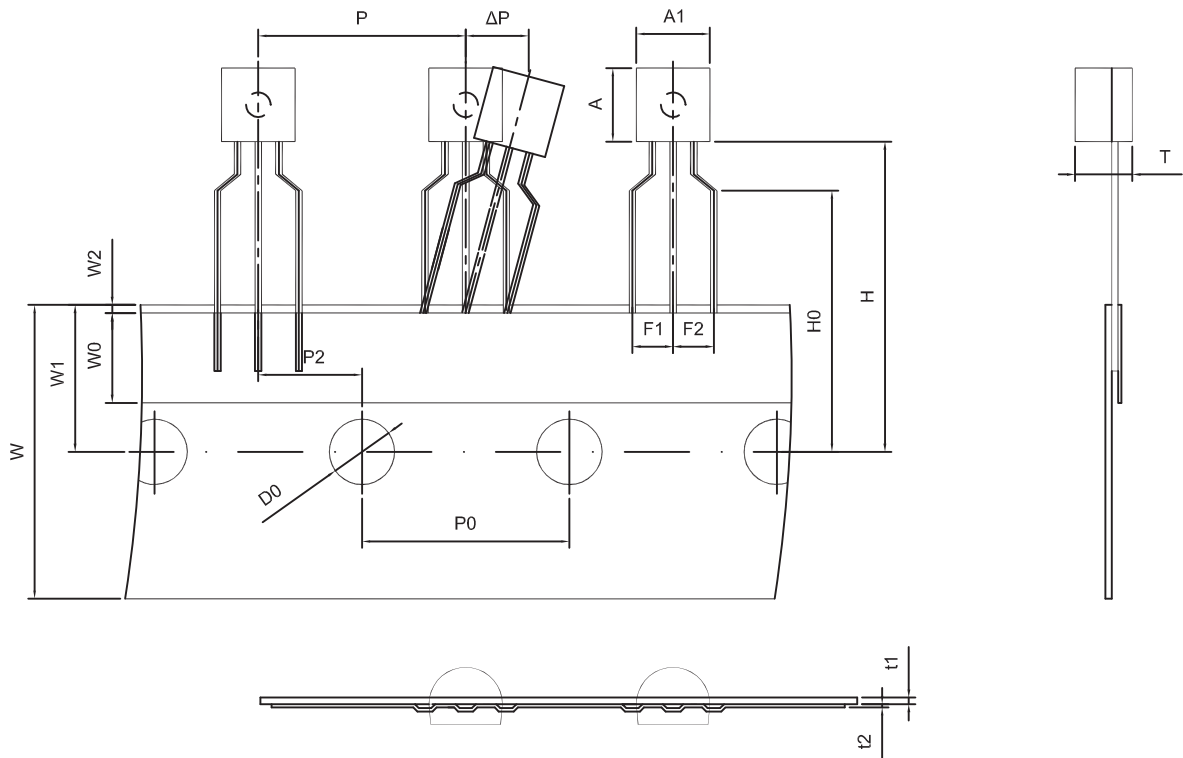

Dimensions are in millimeter

A1	A	T	P	P0	P2	F1	F2	W
4.5	4.5	3.5	12.7	12.7	6.35	2.5	2.5	18.0
W0	W1	W2	H	H0	D0	t1	t2	ΔP
6.0	9.0	1.0 MAX.	19.0	16.0	4.0	0.4	0.2	0

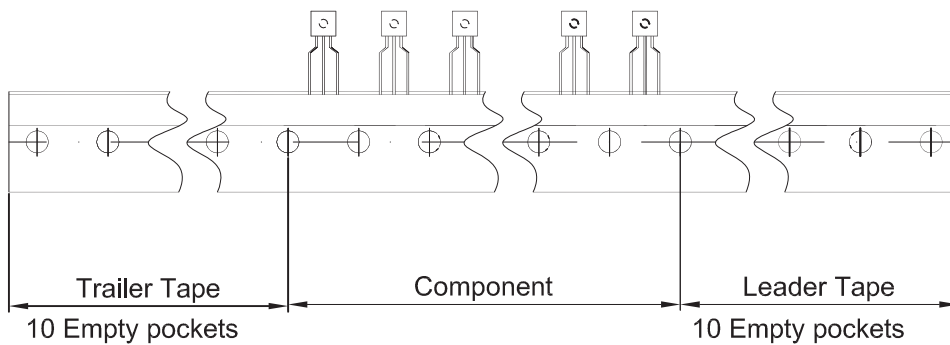

Package	Box	Box Size(mm)	Carton	Carton Size(mm)
TO-92	2000 pcs	333×162×43	20,000 pcs	350×340×250