

SILICON BRIDGE RECTIFIER

REVERSE VOLTAGE : 50 --- 1000 V CURRENT: 25.0 A

FEATURES

- Rating to 1000V PRV
- Surge overload rating to 300Amperes peak Ideal for printed circuit board
- Reliable low cost construction utilizing molded plastic technique results in inexpensive product Lead solderable per MIL-STD-202 method 208
- High case dielectric with standing voltage of 2500 VRMS
- High efficiency

MECHANICAL DATA

- Case style: KBPC plastic molded
- Mounting: thru hole for # 8 screw mounting

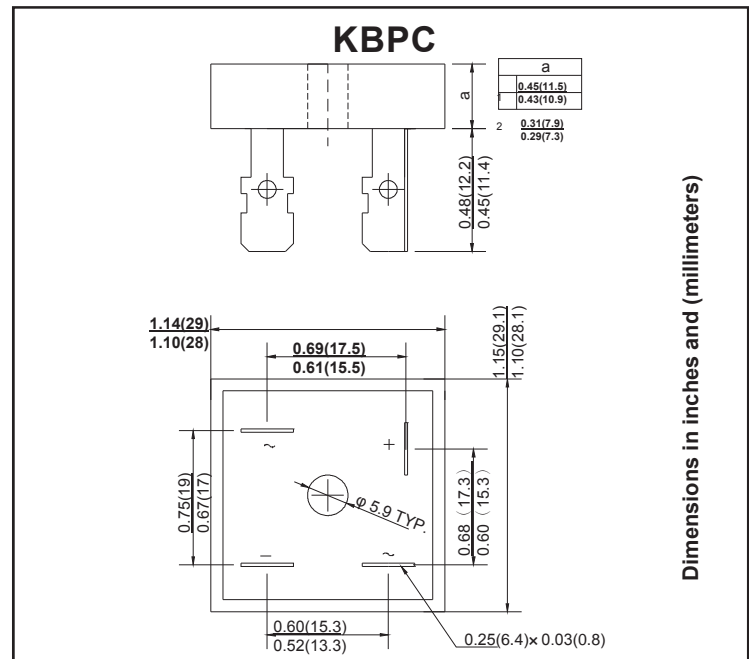

MAXIMUM RATINGS AND CHARACTERISTICS

@ 25°C Ambient Temperature (unless otherwise noted) Single phase, half wave, 60 Hz, resistive or inductive load.
For capacitive load, derate by 20%.

		KBPC 25005	KBPC 2501	KBPC 2502	KBPC 2504	KBPC 2506	KBPC 2508	KBPC 2510	UNITS
Maximum recurrent peak reverse voltage	V_{RRM}	50	100	200	400	600	800	1000	V
Maximum RMS voltage	V_{RMS}	35	70	140	280	420	560	700	V
Maximum DC blocking voltage	V_{DC}	50	100	200	400	600	800	1000	V
Maximum average forward Output current @ $T_A=25^\circ\text{C}$	$I_{F(AV)}$	25.0							A
Peak forward surge current 8.3ms single half-sine-wave superimposed on rated load	I_{FSM}	300.0							A
Maximum instantaneous forward voltage @ 12.5 A	V_F	1.1							V
Maximum reverse current @ $T_A=25^\circ\text{C}$ at rated DC blocking voltage @ $T_A=100^\circ\text{C}$	I_R	10.0 1.0							μA mA
Operating junction temperature range	T_J	- 55 ---- + 125							$^\circ\text{C}$
Storage temperature range	T_{STG}	- 55 ---- + 150							$^\circ\text{C}$

RATINGS AND CHARACTERISTIC CURVES

FIG.1 – PEAK FORWARD SURGE CURRENT

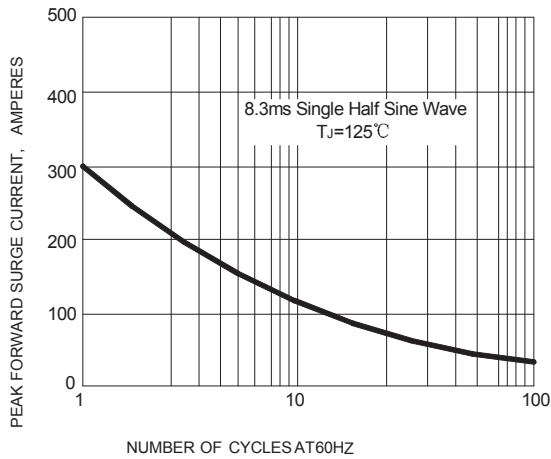

FIG.2 – FORWARD DERATING CURVE

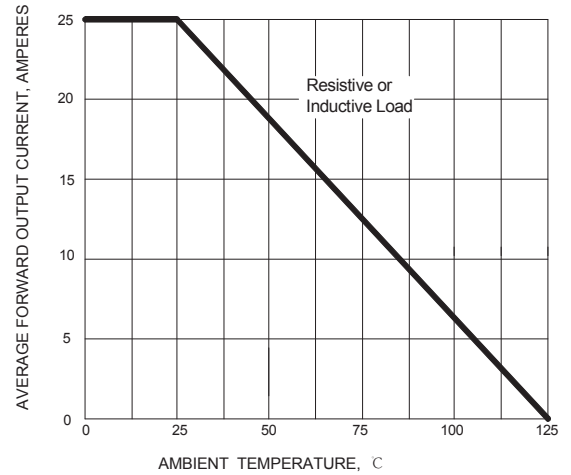

FIG.3 – TYPICAL FORWARD CHARACTERISTIC

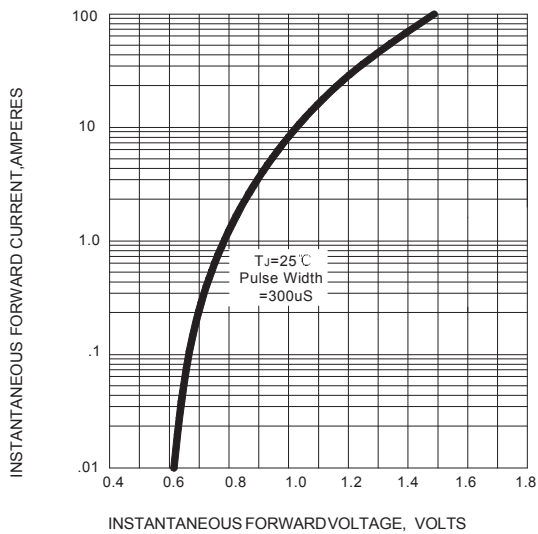

FIG.4 – TYPICAL REVERSE CHARACTERISTIC

