

Three-terminal positive voltage regulator

FEATURES

- Maximum output current IOM: 0.5 A
- Output voltage VO: 12V
- Continuous total dissipation

$$P_D: 1.25 \text{ W (} T_a = 25^\circ \text{C)}$$

MECHANICAL DATA

- Case: TO-252 Small Outline Plastic Package
- Polarity: Color band denotes cathode end
- Mounting Position: Any

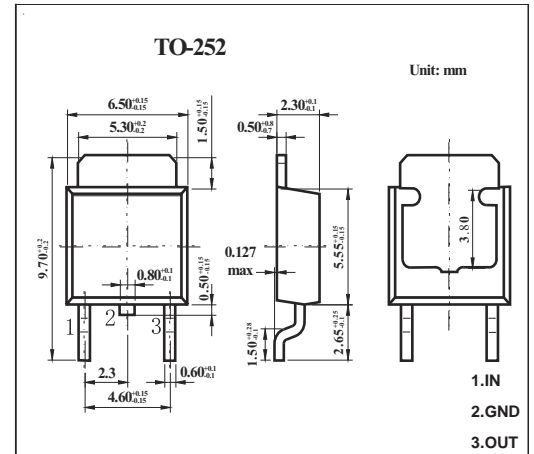

ABSOLUTE MAXIMUM RATINGS

(Operating temperature range applies unless otherwise specified)

Parameter	Symbol	Value	Unit
Input Voltage	V_i	35	V
Thermal Resistance from Junction to Ambient	$R_{\theta JA}$	80	$^\circ\text{C/W}$
Operating Junction Temperature Range	T_{OPR}	-25~+125	$^\circ\text{C}$
Storage Temperature Range	T_{STG}	-65~+150	$^\circ\text{C}$

ELECTRICAL CHARACTERISTICS ($V_i=19\text{V}$, $I_o=350\text{mA}$, $C_i=0.33\mu\text{F}$, $C_o=0.1\mu\text{F}$, unless otherwise specified)

Parameter	Symbol	Test conditions	Min	Typ	Max	Unit
Output Voltage	V_o	25°C	11.5	12	12.5	V
		$14.5 \leq V_i \leq 27\text{V}$, $I_o=5\text{mA}-350\text{mA}$	-25-125 $^\circ\text{C}$	11.4	12	12.6
Load Regulation	ΔV_o	$I_o=5\text{mA}-500\text{mA}$	25°C	25	240	mV
		$I_o=5\text{mA}-200\text{mA}$	25°C	10	120	mV
Line Regulation	ΔV_o	$14.5 \leq V_i \leq 30\text{V}$, $I_o=200\text{mA}$	25°C	10	100	mV
		$16 \leq V_i \leq 30\text{V}$, $I_o=200\text{mA}$	25°C	3	50	mV
Quiescent Current	I_q	25°C		4.6	6	mA
Quiescent Current Change	ΔI_q	$14.5 \leq V_i \leq 30\text{V}$, $I_o=200\text{mA}$	-25-125 $^\circ\text{C}$		0.8	mA
		$5\text{mA} \leq I_o \leq 350\text{mA}$	-25-125 $^\circ\text{C}$		0.5	mA
Output Noise Voltage	V_N	$10\text{Hz} \leq f \leq 100\text{KHz}$	25°C	75		$\mu\text{V}/V_o$
Ripple Rejection	RR	$15 \leq V_i \leq 25\text{V}$, $f=120\text{Hz}$, $I_o=300\text{mA}$	-25-125 $^\circ\text{C}$	55	80	dB
Dropout Voltage	V_d	$I_o=350\text{mA}$	25°C	2		V
Short Circuit Current	I_{sc}	$V_i=19\text{V}$	25°C	240		mA
Peak Current	I_{pk}		25°C	0.7		A

* Pulse test.

TYPICAL APPLICATION

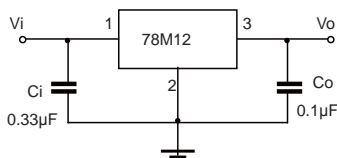

Note: Bypass capacitors are recommended for optimum stability and transient response and should be located as close as possible to the regulators.

RATINGS AND CHARACTERISTIC CURVES

Typical Characteristics

Output Characteristics

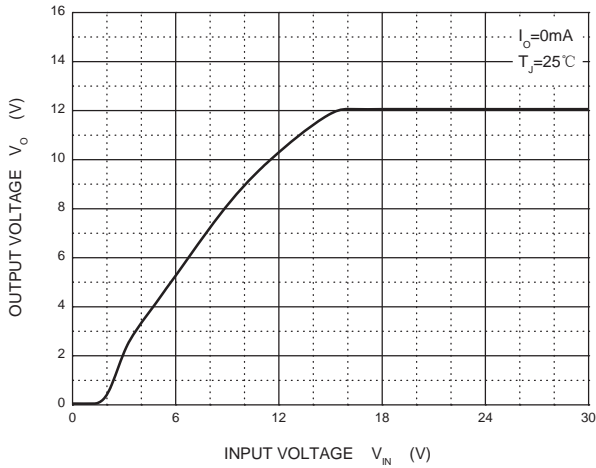

Dropout Characteristics

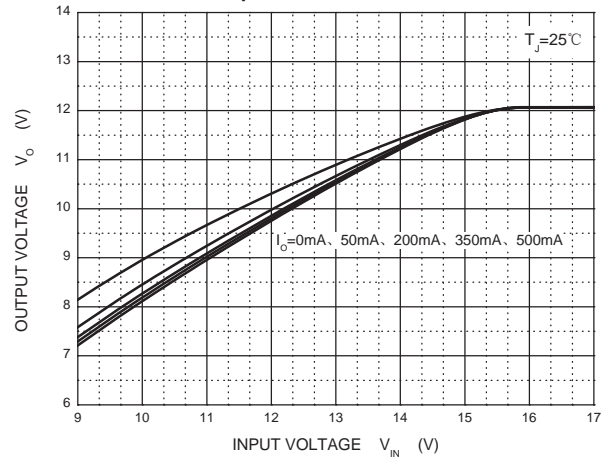

Quiescent Current vs Input Voltage

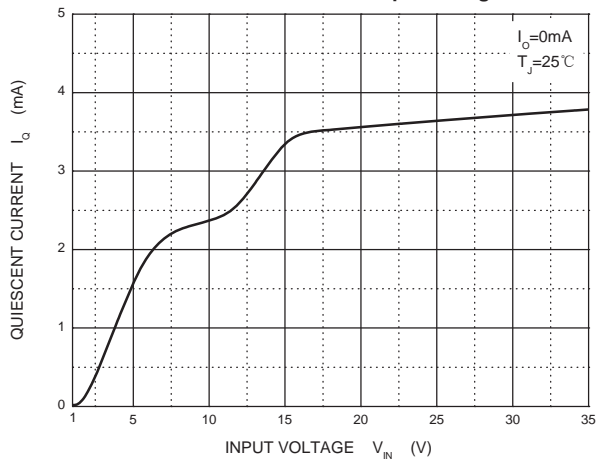

Current Cut-off Grid Voltage

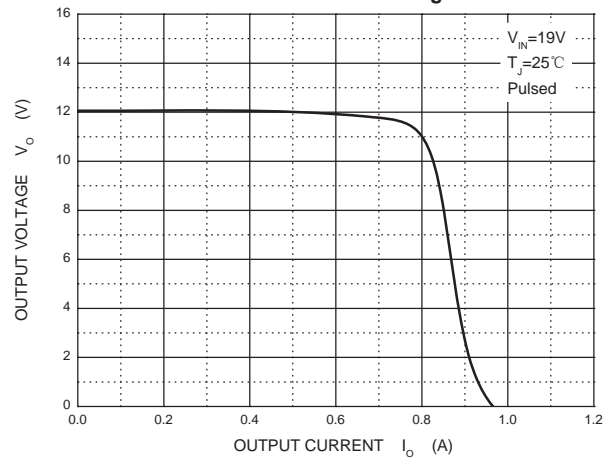

Output Voltage vs Junction Temperature

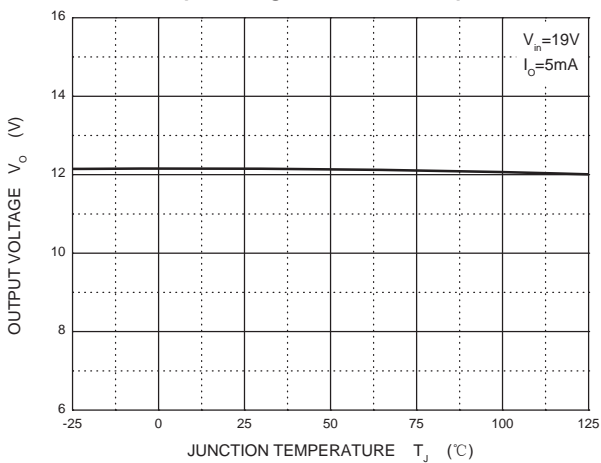

Power Derating Curve

