

## TO-92MOD Plastic-Encapsulate Transistors

### FEATURES

- Low Frequency Power Amplifier
- Complementary Pair with 2SB647/A
- TRANSISTOR (NPN)

### MECHANICAL DATA

- Case style: TO-92MOD molded plastic
- Mounting position: any

### TO-92MOD

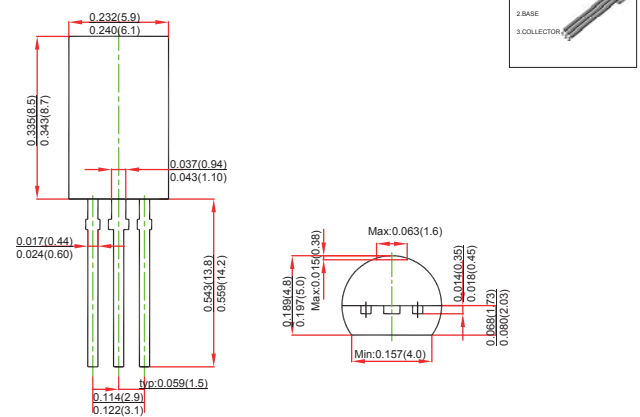

## MAXIMUM RATINGS AND CHARACTERISTICS

@ 25°C Ambient Temperature (unless otherwise noted)

Symbol	Parameter	Value	Unit
$V_{CBO}$	Collector- Base Voltage	120	V
$V_{CEO}$	Collector-Emitter Voltage	2SD667	80
		2SD667A	100
$V_{EBO}$	Emitter-Base Voltage	5	V
$I_C$	Collector Current -Continuous	1	A
$P_C$	Collector Power Dissipation	900	mW
$T_J$	Junction Temperature	150	°C
$T_{stg}$	Storage Temperature	-55-150	°C

### ORDERING INFORMATION

Part Number	Package	Packing Method	Pack Quantity
2SD667	TO-92MOD	Bulk	500pcs/Bag
2SD667-TA	TO-92MOD	Tape	2000pcs/Box
2SD667A	TO-92MOD	Bulk	500pcs/Bag
2SD667A-TA	TO-92MOD	Tape	2000pcs/Box

Parameter	Symbol	Test conditions	Min	Typ	Max	Unit
Collector-base breakdown voltage	$V_{(BR)CBO}$	$I_C=10\mu A, I_E=0$	120			V
Collector-emitter breakdown voltage	$V_{(BR)CEO}$	$I_C=1mA, I_B=0$	2SD667	80		V
			2SD667A	100		V
Emitter-base breakdown voltage	$V_{(BR)EBO}$	$I_E=10\mu A, I_C=0$	5			V
Collector cut-off current	$I_{CBO}$	$V_{CB}=100V, I_E=0$			10	$\mu A$
Emitter cut-off current	$I_{EBO}$	$V_{EB}=4V, I_C=0$			10	$\mu A$
DC current gain	$h_{FE(1)}$	$V_{CE}=5V, I_C=150mA$	2SD667	60	320	
			2SD667A	60	320	
	$h_{FE(2)}$	$V_{CE}=5V, I_C=500mA$	30			
Collector-emitter saturation voltage	$V_{CE(sat)}$	$I_C=500mA, I_B=50mA$			1	V
Base-emitter voltage	$V_{BE}$	$V_{CE}=5V, I_C=150mA$			1.5	V
Transition frequency	$f_T$	$V_{CE}=5V, I_C=150mA$		140		MHz
Collector output capacitance	$C_{ob}$	$V_{CB}=10V, I_E=0, f=1MHz$		12		pF

### CLASSIFICATION OF $h_{FE(1)}$

Rank		B	C	D
Range	2SD667	60-120	100-200	160-320
	2SD667A	60-120	100-200	160-320

### MARKING

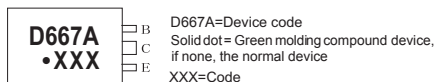
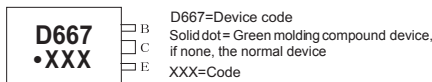

### Equivalent Circuit

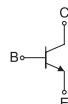

# RATINGS AND CHARACTERISTIC CURVES

Typical Characteristics

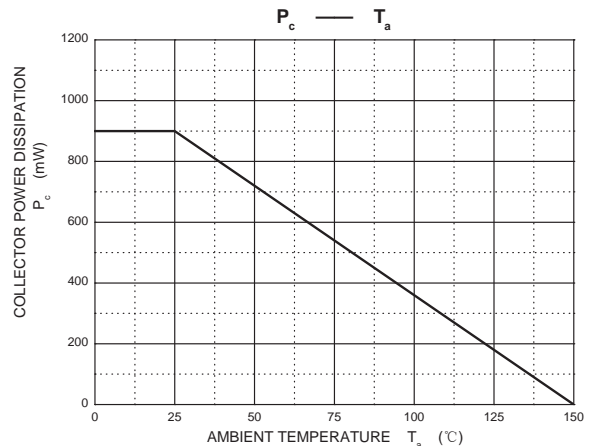
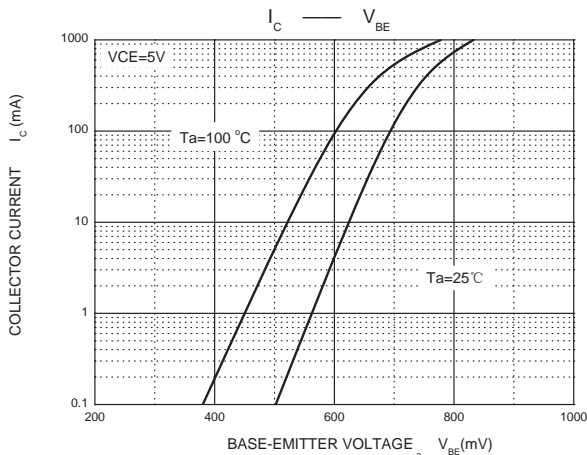
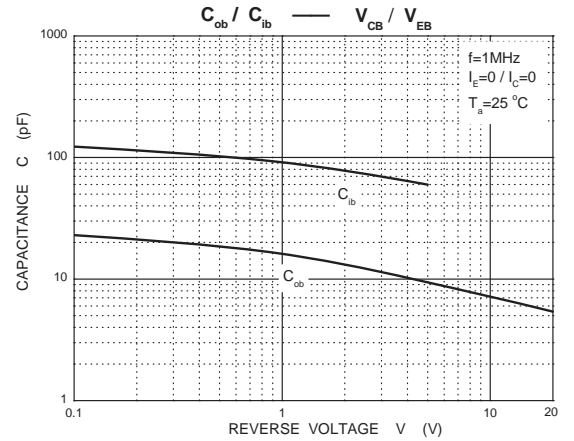
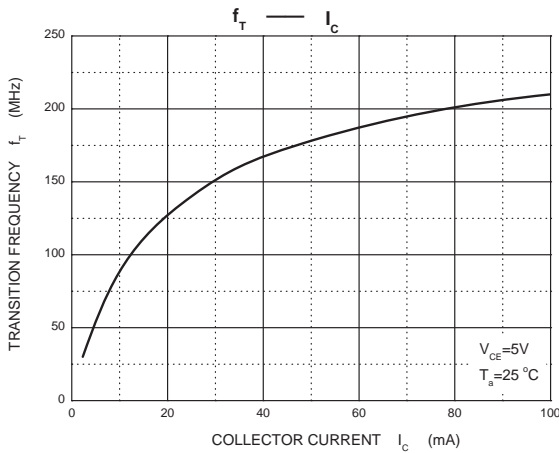
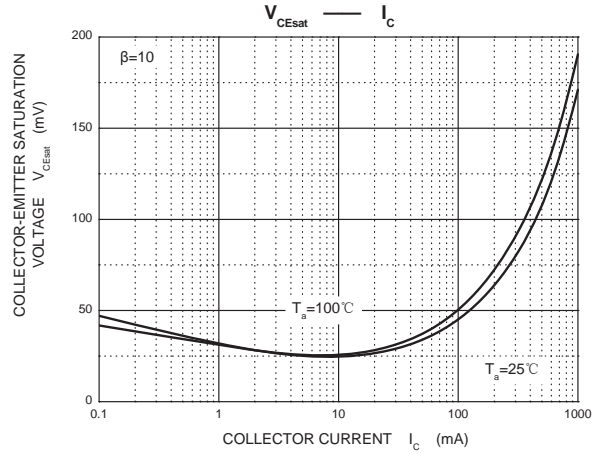
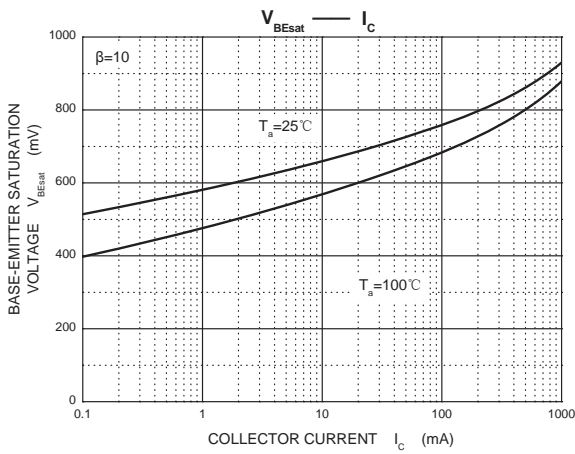
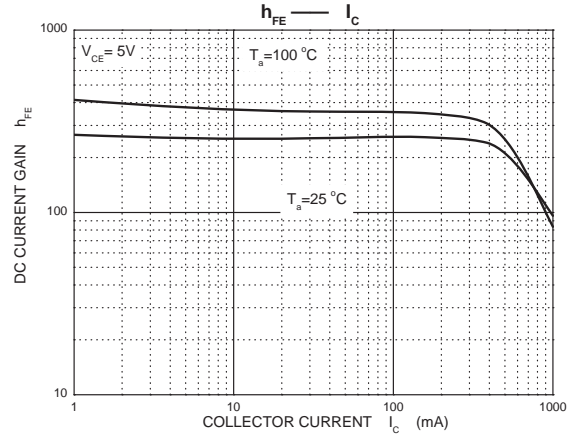
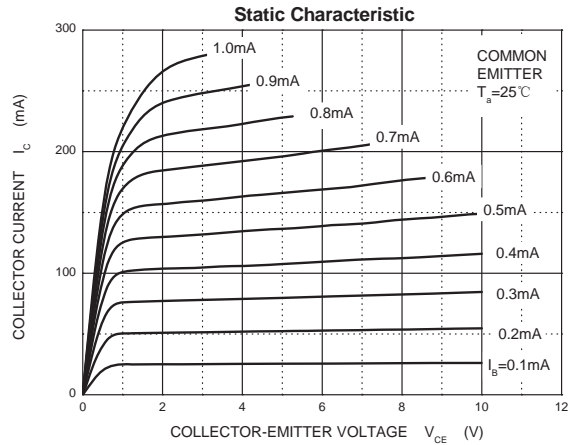

# TO-92MOD PACKAGE TAPEING DIMENSION

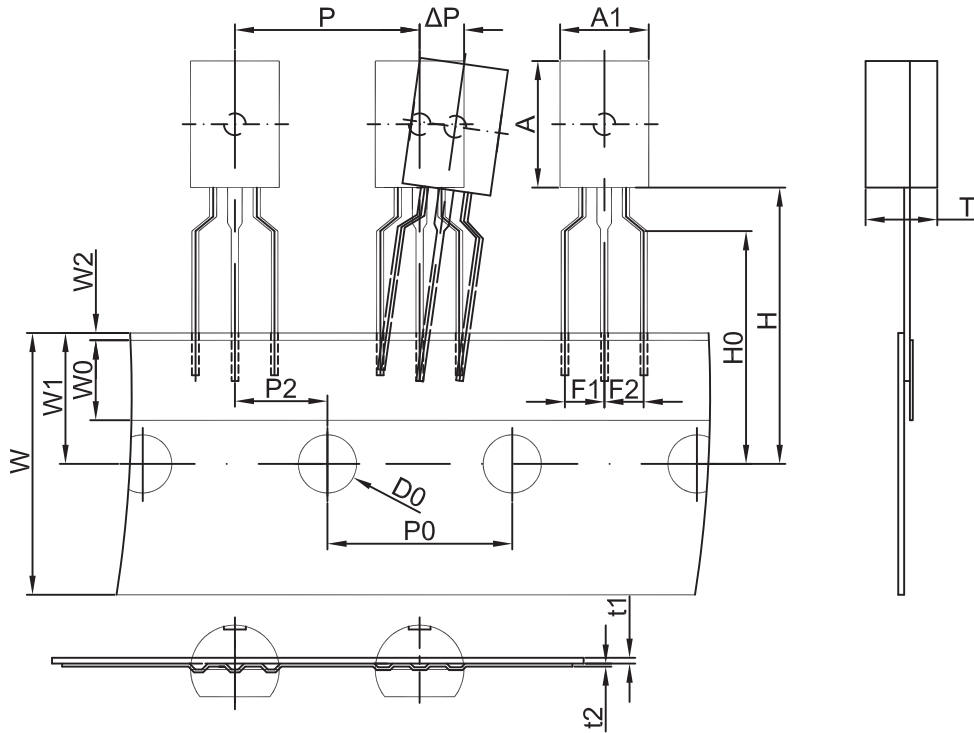

Dimensions are in millimeter

A1	A	T	P	P0	P2	F1	F2	W
6.0	8.6	4.9	12.7	12.7	6.35	2.5	2.5	18.0
W0	W1	W2	H	H0	D0	t1	t2	ΔP
6.0	9.0	1.0	19.0	16.0	4.0	0.4	0.2	0

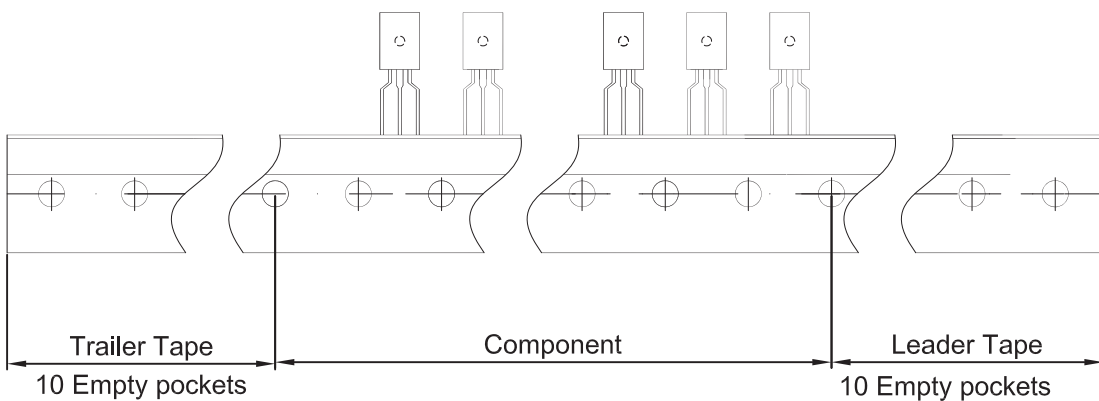

Package	Box	Box Size(mm)	Carton	Carton Size(mm)
TO-92MOD	2000 pcs	333×245×43	20,000 pcs	573×404×266