

SOT-23 Plastic-Encapsulate Transistors

Features

- Collector Current Capability $I_c=50\text{mA}$
- Collector Emitter Voltage $V_{CE0}=30\text{V}$
- NPN silicon transistor

MECHANICAL DATA

- Case style:SOT-23molded plastic
- Mounting position:any

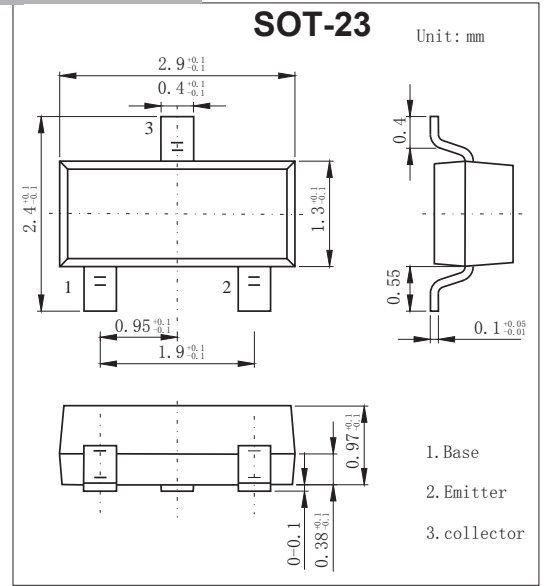

MAXIMUM RATINGS AND CHARACTERISTICS

@ 25°C Ambient Temperature (unless otherwise noted)

Parameter	Symbol	Rating	Unit
Collector - Base Voltage	V_{CB0}	35	V
Collector - Emitter Voltage	V_{CE0}	30	
Emitter - Base Voltage	V_{EB0}	4	
Collector Current - Continuous	I_c	50	mA
Base Current	I_B	10	
Collector Power Dissipation	P_C	150	mW
Junction Temperature	T_J	125	°C
Storage Temperature Range	T_{stg}	-55 to 125	

PACKAGE INFORMATION

Device	Package	Shipping
2SC2715	SOT-23	3000/Tape&Reel

Parameter	Symbol	Test Conditions	Min	Typ	Max	Unit
Collector- base breakdown voltage	V_{CB0}	$I_c=100\mu\text{A}, I_E=0$	35			V
Collector- emitter breakdown voltage	V_{CE0}	$I_c=1\text{mA}, I_B=0$	30			
Emitter - base breakdown voltage	V_{EB0}	$I_E=100\mu\text{A}, I_c=0$	4			
Collector-base cut-off current	I_{CBO}	$V_{CB}=35\text{V}, I_E=0$			0.1	uA
Emitter cut-off current	I_{EBO}	$V_{EB}=4\text{V}, I_c=0$			0.1	
Collector-emitter saturation voltage	$V_{CE(sat)}$	$I_c=10\text{mA}, I_B=1\text{mA}$			0.4	V
Base - emitter saturation voltage	$V_{BE(sat)}$	$I_c=10\text{mA}, I_B=1\text{mA}$			1.2	
Base - emitter voltage	V_{BE}	$V_{CE}=10\text{V}, I_c=1\text{mA}$			1	
DC current gain	h_{FE}	$V_{CE}=12\text{V}, I_c=2\text{mA}$	40		240	
Collector-base time constant	$C_{c\text{ rbb}'}$	$V_{CE}=10\text{V}, I_E=-1\text{mA}, f=30\text{MHz}$			50	ps
Power gain	PG	$V_{CC}=6\text{V}, I_E=-1\text{mA}, f=10.7\text{MHz}$	27		33	dB
Collector output capacitance	C_{ob}	$V_{CB}=10\text{V}, I_E=0, f=1\text{MHz}$			3.2	pF
Transition frequency	f_T	$V_{CE}=10\text{V}, I_c=1\text{mA}$	100		400	MHz

Classification of h_{FE}

Type	2SC2715-R	2SC2715-O	2SC2715-Y
Range	40-80	70-140	120-240
Marking	RR	RO	RY



RATINGS AND CHARACTERISTIC CURVES

Typical Characteristics

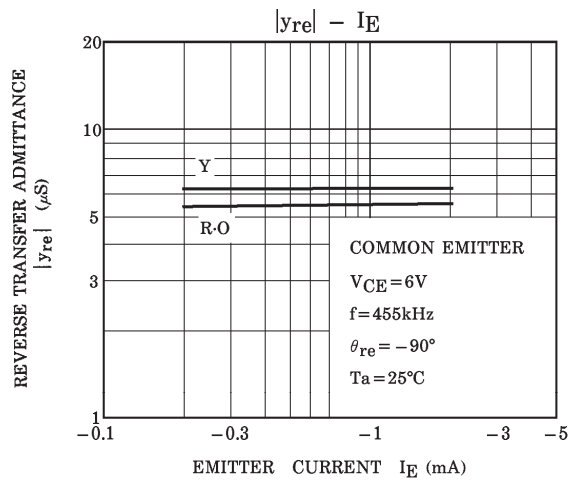
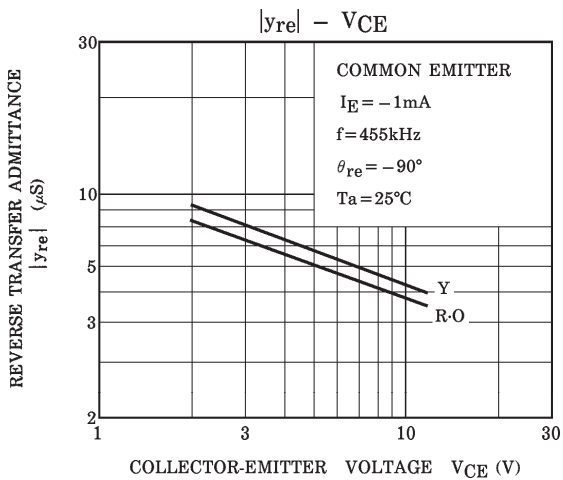
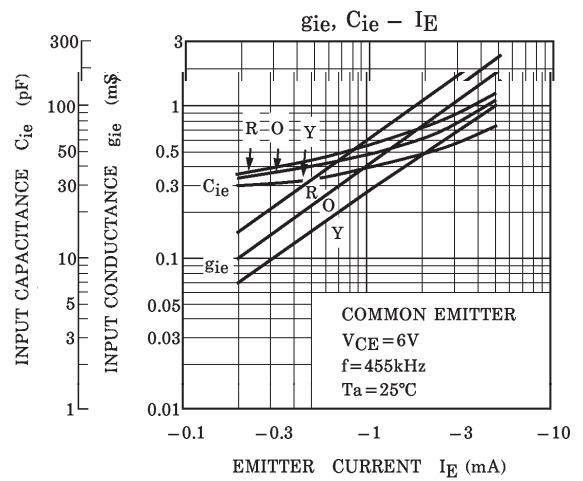
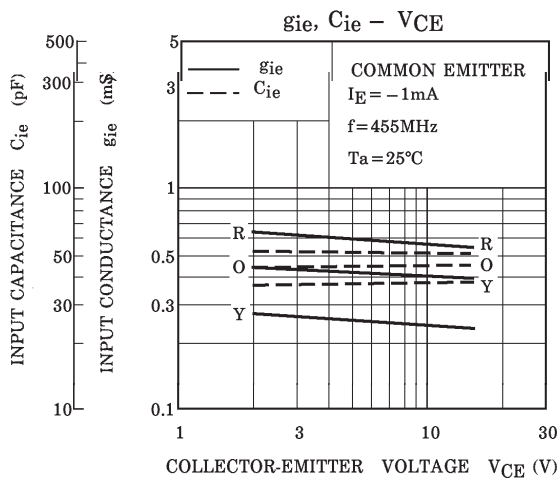
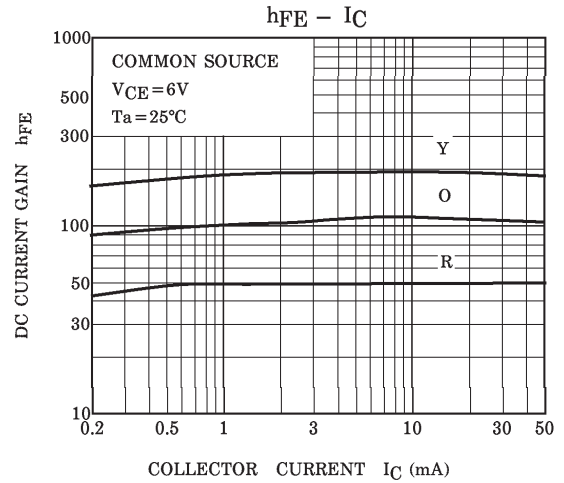
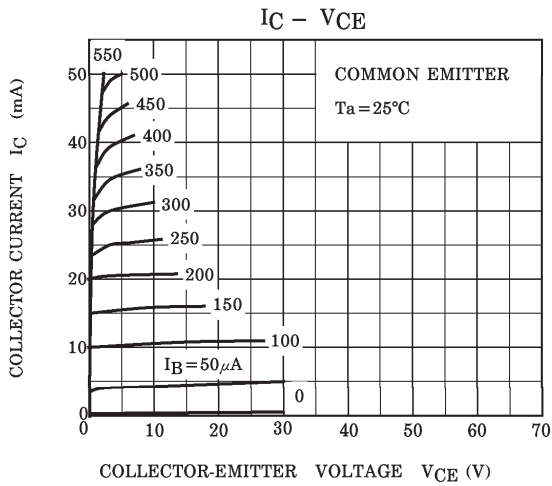



RATINGS AND CHARACTERISTIC CURVES

Typical Characteristics

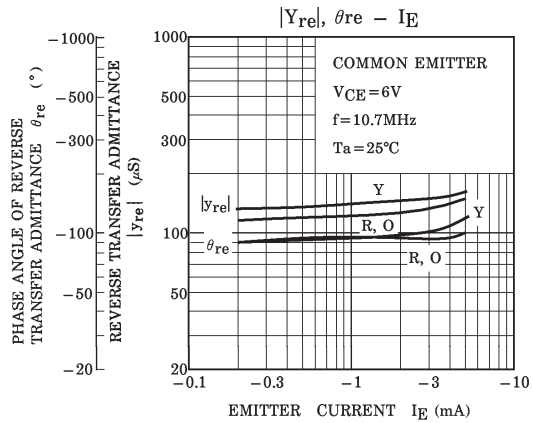
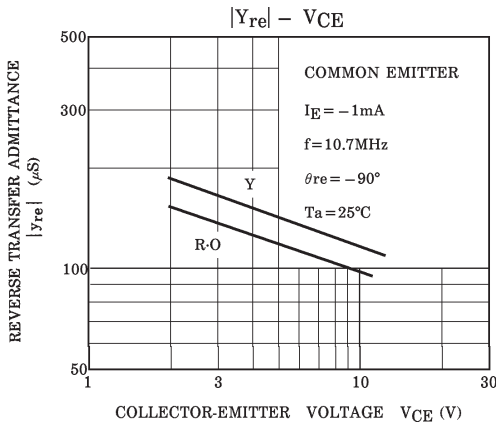
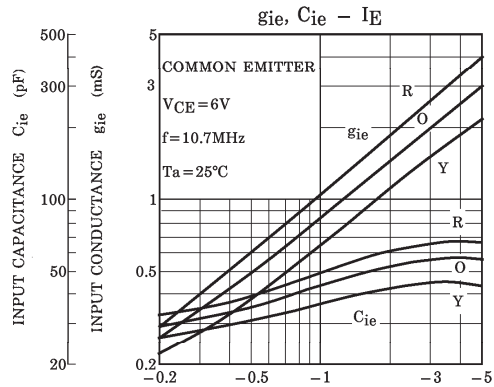
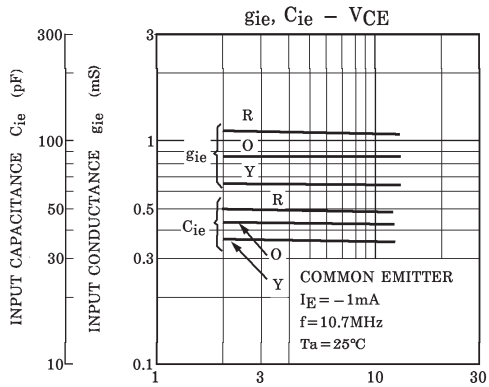
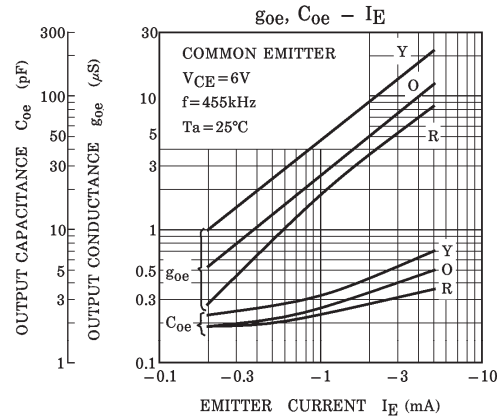
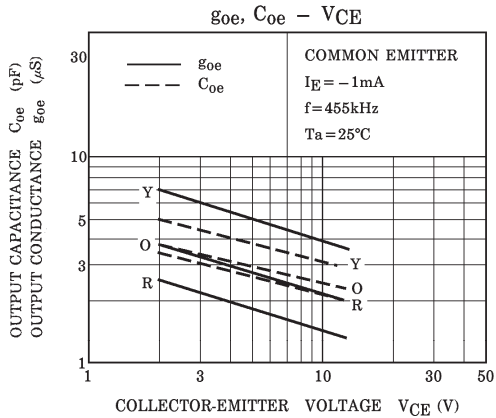
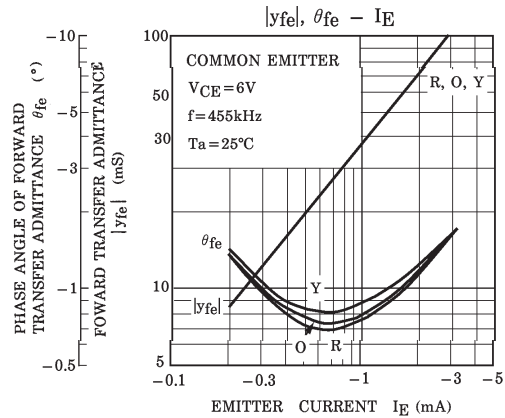
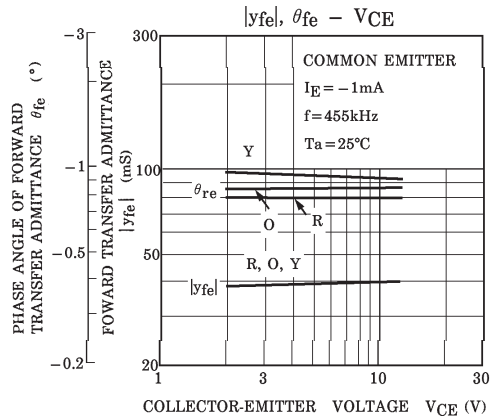

■ Typical Characteristics

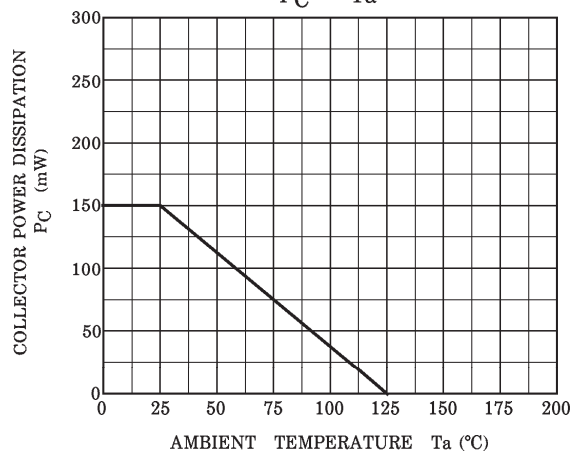
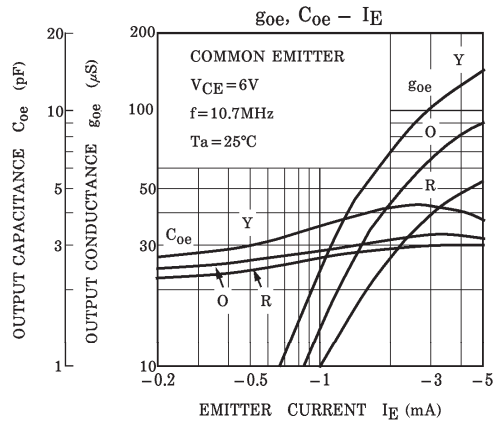
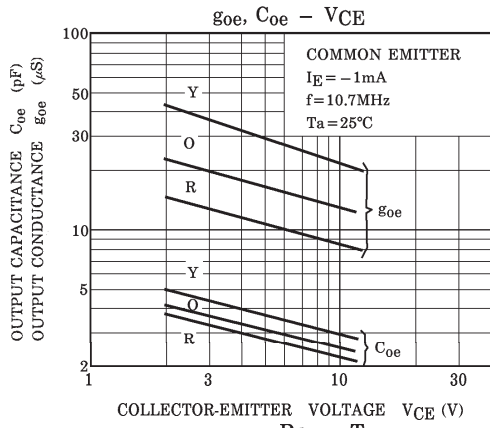
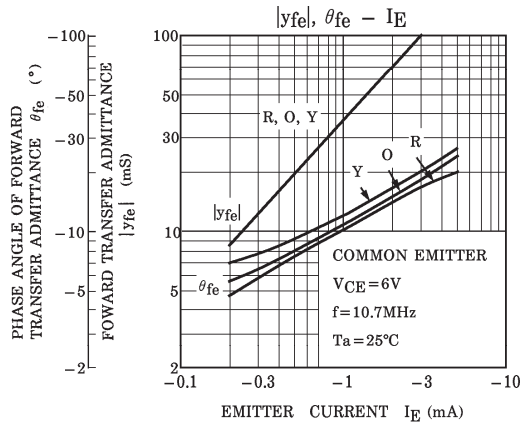
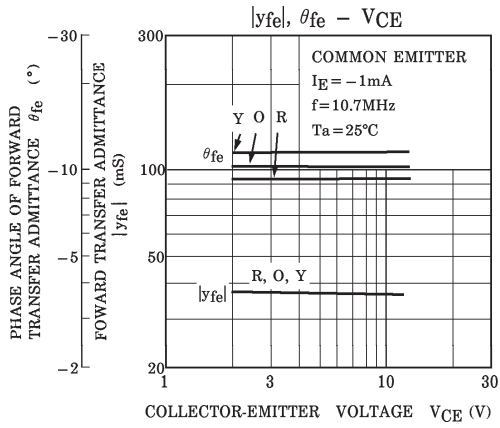
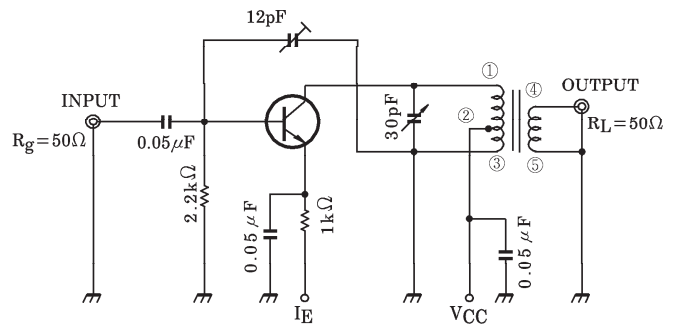

Fig. NF, Gpe TEST CIRCUIT



- T : ①-② 0.1mm ϕ UEW 20T
- ②-③ 0.1mm ϕ UEW 8T
- ④-⑤ 0.1mm ϕ UEW 2T